



GENIOWALLART.COM

g CLETTICO
ITALIANO

WALL DECOR SYSTEM
VOLUME 1

ADRIANI & ROSSI®
DISCOVER YOUR GENIUS

SINCE 1990

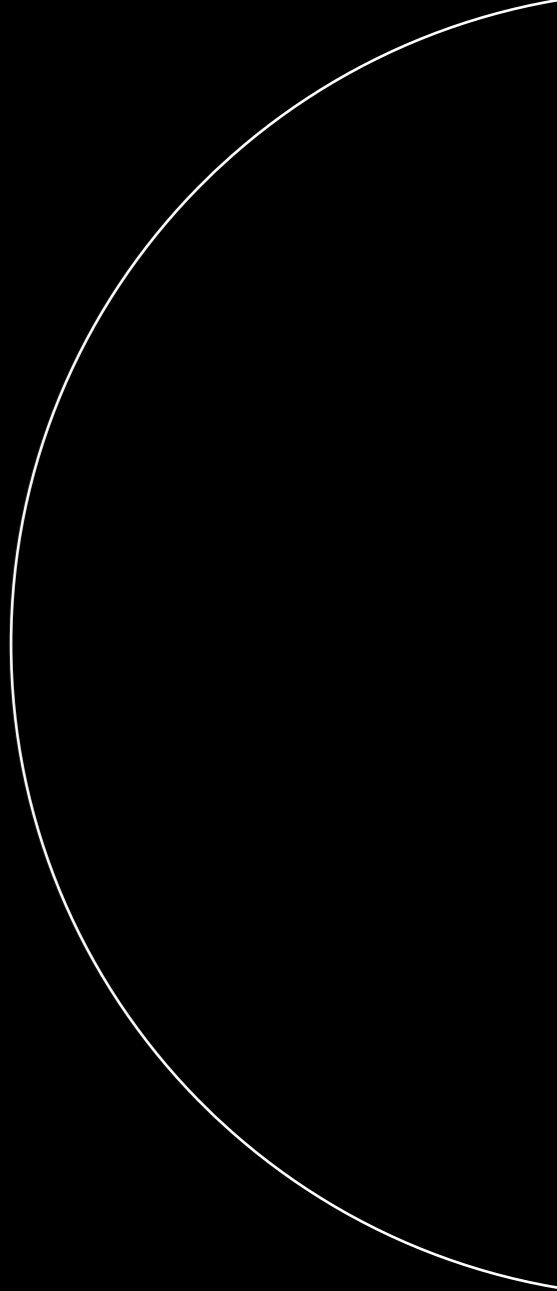



ADRIANI & ROSSI®
DISCOVER YOUR GENIUS

ECLETTICO
ITALIANO

ECLETTICO reinventa il concetto stesso di boiserie, in quanto non è più solo un elemento decorativo ma anche funzionale. I pannelli **ECLETTICO** sono espressione raffinata di stile in grado di dare nutrimento vitale alla matita del designer e allo spazio di un ambiente. **ECLETTICO RITMO** a cannettè, contraddistingue **ECLETTICO** facendolo diventare fonte di ispirazione artistica con cui poter decorare qualsiasi tipo di ambiente, che abbinato a giochi di luce integrabili, finiture di ogni tipo e materiali complementari, crea profondità, ampiezza e benessere di grande effetto.

ECLETTICO reinvents the very concept of boiserie, as it is no longer just a decorative element but also a functional one. **ECLETTICO** panels are a refined expression of style capable of giving vital nourishment to the designer's pencil and to the space of an environment. The cannettè **ECLETTICO RITMO** distinguishes Eclettico by making it a source of artistic inspiration with which any type of environment can be decorated and can be combined with integrable plays of light, all kinds of finishings and complementary materials. It creates depth, width and well-being of great effect.

Entra nel sito internet e scarica tutte le collezioni Adriani e Rossi nella sezione "DOWNLOAD CATALOGHI".

Enter the website and download all Adriani & Rossi collections in the "Download Catalogues" section.



Adriani & Rossi supports: **BAMBINI DELLE FATE**

ADRIANI & ROSSI Collections



Atelier
Vol. 3
Objects and complements



Objects
Vol. 8



Wallpaper
Vol. 4



Hi-Res Materials
Vol. 1
Wallpaper Collection



100% Real Cement
Vol. 1
Wallpaper Collection



Garage Design
Vol. 1



ECCLETTICO
ITALIANO

SU MISURA

ECLETTICO È STATO STUDIATO PER ESSERE PERSONALIZZABILE E RISOLVERE LE TUE ESIGENZE PROGETTUALI. VIENE OFFERTO IN UNA VASTA GAMMA DI COLORI E FINIUTRE ESTETICHE COME LUCIDO E OPACO, CANNETTE', TECNICHE COME SPECCHI FUMÈ O ARGENTO, LAVAGNE SCURE PER SCRIVERE CON GESSETTI O LAVAGNE BIANCHE DI AMPIA DIMENSIONE PER PENNARELLI. INOLTRE TUTTE LE SUPERFICI SONO PERSONALIZZABILI CON LOGHI O IMMAGINI OTTENUTE ATTRAVERSO STAMPE DIGITALI AD ALTISSIMA RESISTENZA E DI ULTIMA GENERAZIONE.

TAILORED

ECLETTICO HAS BEEN DESIGNED TO BE CUSTOMIZABLE AND SOLVE YOUR DESIGN NEEDS. IT IS OFFERED IN A WIDE RANGE OF COLORS AND AESTHETIC FINISHES SUCH AS GLOSSY AND MATTE, CANNETTÈ, ALSO TECHNIQUES SUCH AS SMOKED OR SILVER MIRRORS, DARK BLACKBOARDS FOR WRITING WITH CHALKS OR LARGE WHITEBOARDS FOR MARKERS. FURTHERMORE, ALL THE SURFACES CAN BE CUSTOMIZED WITH LOGOS OR IMAGES OBTAINED THROUGH HIGHLY RESISTANT AND LATEST GENERATION DIGITAL PRINTS.

COSTO FACILE DA CALCOLARE

L'ESIGENZA DI AVERE COSTI CERTI, UN PRODOTTO QUALITATIVAMENTE GARANTITO E LA FACILITÀ DELLA POSA IN OPERA DELLO STESSO, SONO FATTORI FONDAMENTALI PER LA BUONA RIUSCITA DI UN PROGETTO E LA SODDISFAZIONE DEL CLIENTE FINALE. CON **ECLETTICO**, PENSIAMO A TUTTO NOI FORNENDO IL PANNELLO CORREDATO DI TUTTI GLI ACCESSORI NECESSARI PER POTERLO INSTALLARE IN MODO PERFETTO NELL'AMBIENTE CHE SI DESIDERA DECORARE. GRAZIE ALLA SUA MODULARITÀ E AL SUO SISTEMA DI FISSAGGIO SEQUENZIALE È FACILE CALCOLARE CON PERFETTA PRECISIONE IL COSTO COMPLESSIVO FINALE DEL PROGETTO CHE SI VUOLE REALIZZARE.

EASY TO CALCULATE COST

THE NEED TO HAVE CERTAIN COSTS, A QUALITATIVELY GUARANTEED PRODUCT AND THE EASE OF INSTALLATION OF THE SAME ARE FUNDAMENTAL FACTORS FOR THE SUCCESS OF A PROJECT AND THE END CUSTOMER SATISFACTION. WITH **ECLETTICO**, WE TAKE CARE OF EVERYTHING BY PROVIDING THE PANEL WITH ALL THE NECESSARY ACCESSORIES IN ORDER TO INSTALL IT PERFECTLY IN THE ENVIRONMENT YOU WANT TO DECORATE. THANKS TO ITS MODULARITY AND ITS SEQUENTIAL FIXING SYSTEM, THE FINAL TOTAL COST OF THE PROJECT TO BE CARRIED OUT IS EASY TO CALCULATE WITH PERFECT PRECISION.

NIENTE PIÙ SPORCO

ECLETTICO È UN PRODOTTO CHE NON SI ROVINA DURANTE IL MONTAGGIO PERCHÈ È PROTETTO DA UN FILM PROTETTIVO E NON SPORCA L'AMBIENTE PERCHÈ È UN PRODOTTO GIÀ FINITO QUANDO VIENE INSTALLATO. NON NECESSITA DI ALCUNA LAVORAZIONE DI FINITURA SUPERIFICIALE AGGIUNTIVA. A FINE LAVORO BASTA TOGLIERE IL FILM PROTETTIVO E LAVARLO CON UN PANNO MORBIDO E UNA SOLUZIONE DI ACQUA E SAPONE NEUTRALE. GRAZIE A QUESTE CARATTERISTICHE **ECLETTICO** È IL PRODOTTO IDEALE PER ESSERE INSTALLATO IN AMBIENTI SENZA LA NECESSITÀ DI FERMARE LE ATTIVITÀ LAVORATIVE PER LUNGO TEMPO.

NO MORE DIRTY

ECLETTICO IS A PRODUCT THAT DOES NOT GET DAMAGED DURING ASSEMBLY BECAUSE IT IS PROTECTED BY A PROTECTIVE FILM AND DOES NOT DIRTY THE ENVIRONMENT BECAUSE IT IS A FINISHED PRODUCT WHEN INSTALLED. IT DOES NOT REQUIRE ANY ADDITIONAL SURFACE FINISHING WORK. AT THE END OF THE WORK JUST REMOVE THE PROTECTIVE FILM, WASH IT WITH A SOFT CLOTH, USE A SOLUTION OF WATER AND NEUTRAL SOAP. THANKS TO THESE FEATURES, **ECLETTICO** IS THE IDEAL PRODUCT TO BE INSTALLED IN ENVIRONMENTS WITHOUT THE NEED TO STOP WORKING ACTIVITIES FOR A LONG TIME.

RISULTATO PERFETTO

IL RISULTATO FINALE DEL LAVORO CHE SI EFFETTUA CON I PANNELLI ECLETTICO NON È VINCOLATO ALLA PROFESSIONALITÀ DI CHI ESEGUE IL MONTAGGIO COME NELLE CARTE DA PARATI O NELL'APPLICARE UN CARTONGESSO O IN UNA PARTICOLARE TINTEGGIATURA DEL MURO. ECLETTICO CON LA SUA MODULARITÀ, LA PLANARITÀ DELLA SUPERFICIE E LA SUA SEMPLICITÀ DI MONTAGGIO FA LA DIFFERENZA QUALITATIVA DEL RISULTATO FINALE.

PERFECT RESULT

THE FINAL RESULT OF THE WORK THAT IS CARRIED OUT WITH THE ECLETTICO PANELS IS NOT BOUND TO THE PROFESSIONALISM OF THOSE WHO PERFORM THE ASSEMBLY AS IT HAPPENS WITH THE WALLPAPERS OR IN APPLYING PLASTERBOARD OR IN A PARTICULAR PAINTING OF THE WALL. GENIUS WITH ITS MODULARITY MAKES THE QUALITATIVE DIFFERENCE OF THE FINAL RESULT THANKS TO THE FLATNESS OF THE SURFACE AND ITS SIMPLICITY OF ASSEMBLY.

Che cos'è **ECLETTICO**

WHAT IS **ECLETTICO**

ITALIANO

DOVE VIENE PRODOTTO

TUTTA LA COLLEZIONE **ECLETTICO** È PRODOTTA IN ITALIA, IN VENETO. L'AZIENDA CHE HA UNA STORIA LUNGA OLTRE 50 ANNI, PRODUCE PIÙ DI 40 MILIONI DI PEZZI ALL'ANNO E RAPPRESENTA UNA GARANZIA PER QUALITÀ E DISPONIBILITÀ DI MATERIALE.

WHERE IT IS PRODUCED

THE WHOLE **ECLETTICO** COLLECTION IS PRODUCED IN ITALY, IN VENETO. THE COMPANY, WHICH HAS A HISTORY OF OVER 50 YEARS, PRODUCES MORE THAN 40 MILLION PIECES A YEAR AND REPRESENTS A GUARANTEE FOR QUALITY AND AVAILABILITY OF MATERIAL.

E' AUTOPORTANTE

IL PANNELLO **ECLETTICO** DI SPESSORE 18 MM, MONTATO SECONDO LE ISTRUZIONI CONSIGLIATE, DIVENTA AUTOPORTANTE DANDO LA POSSIBILITÀ DI FISSARE SU DI ESSO ELEMENTI COME UN CLIMATIZZATORE, DELLE MENSOLE, UNA TV, FISSANDOSI FACILMENTE IN QUALSIASI PUNTO DELLA SUPERFICIE DEL PANNELLO.

IT'S SELF-SUPPORTING

THE **ECLETTICO** PANEL 18 MM THICK, ASSEMBLED ACCORDING TO THE RECOMMENDED INSTRUCTIONS, BECOMES SELF-SUPPORTING GIVING THE POSSIBILITY TO FIX ELEMENTS ON IT SUCH AS AN AIR CONDITIONER, SHELVES, A TV, FIXING ITSELF EASILY AT ANY POINT ON THE SURFACE OF THE PANEL.

COME NASCE ECLETTICO

ECLETTICO NASCE DALL'UNIONE TRA CREATIVITÀ, SOLUZIONE ALLA PROGETTAZIONE E FORZA PRODUTTIVA. IN 30 ANNI DI ESPERIENZA PROFESSIONALE CON IL NOSTRO STUDIO DI DESIGN PER L'INTERIOR, ABBIAMO DOVUTO AFFRONTARE LE PIÙ DISPARATE SOLUZIONI PROGETTUALI. MOLTE VOLTE DIFFICILI DA REALIZZARE PER L'ASSENZA DI UN PARTNER PRODUTTIVO CHE POTESSE OFFRIRE UN PRODOTTO A PRIMA VISTA SEMPLICE, MA MOLTO EVOLUTO ATTRAVERSO UN KNOW-HOW TECNOLOGICO E QUALITATIVO UNICO NEL SUO MONDO.

HOW ECLETTICO IS BORN

ECLETTICO WAS BORN FROM THE UNION BETWEEN CREATIVITY, DESIGN SOLUTION AND PRODUCTIVE STRENGTH. IN 30 YEARS OF PROFESSIONAL EXPERIENCE WITH OUR INTERIOR DESIGN STUDIO, WE HAD TO DEAL WITH THE MOST DISPARATE DESIGN SOLUTIONS, OFTEN DIFFICULT TO REALIZE BECAUSE OF THE ABSENCE OF A PRODUCTIVE PARTNER WHO COULD OFFER A PRODUCT THAT AT FIRST SIGHT IS SIMPLE, BUT HIGHLY EVOLVED THROUGH A UNIQUE TECHNOLOGICAL AND QUALITATIVE KNOW-HOW IN ITS WORLD.



Ricerca e controllo qualità

RESEARCH AND QUALITY CONTROL



PRODOTTO PIÙ IGIENICO

ESSENDO LA SUPERFICIE PRIVA DI FUGHE DI GIUNZIONE IL PRODOTTO RISULTA PIÙ IGIENICO E FACILE DA PULIRE.

MORE HYGIENIC PRODUCT

SINCE THE SURFACE HAS NO JOINTS, THE PRODUCT IS MORE HYGIENIC AND EASY TO CLEAN.

Sostenibilità

SUSTENIBILITY



I PANNELLI **ECLETTICO** SONO PRODOTTI CON UN RIVESTIMENTO IN PET 100% RICICLATO RICAIVATO DAL RECUPERO DELLE BOTTIGLIE IN PET TRASPARENTE PER IMOTTIGLIARE L'ACQUA MINERALE. FA PARTE DELLA NOSTRA MISSION AZIENDALE CONTINUARE AD INVESTIRE COSTANTMENTE IN MATERIALI ECOSOSTEMIBILI E RICILABILI PER CONTRIBUIRE ALLA SALVAGUARDIA DEL NOSTRO PIANETA.

ECLETTICO PANELS ARE PRODUCED WITH A 100% RECYCLED PET COATING OBTAINED FROM THE RECOVERY OF TRANSPARENT PET BOTTLES FOR BOTTLING MINERAL WATER. IT IS PART OF OUR COMPANY MISSION TO CONTINUE TO CONSTANTLY INVEST IN ECO-SUSTAINABLE AND RECYCLABLE MATERIALS TO CONTRIBUTE TO THE PROTECTION OF OUR PLANET.

Plus & Performance

Download catalogo
GREEN WALLART



Eclettico copre e scopre a piacere tutti gli impianti rendendo l'ambiente pulito e di design.

Eclettico covers and uncovers all the systems as desired, making the environment clean and stylish.

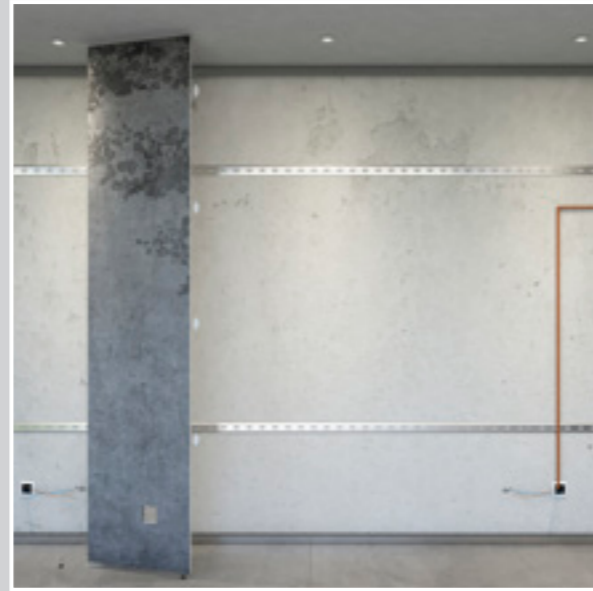

Facilità di montaggio. Eclettico è il nuovo sistema di pannelatura e boiserie che permette di rivestire le pareti con materiali, decorazioni e massima customizzazione al prezzo di una carta da parati. Vuoto sanitario retrostante diventa la vera facilità all'impiantistica.

Easy assembly. Eclectic is the new paneling and boiserie system that allows walls to be covered with materials, decorations and maximum customization at the price of wallpaper. The sanitary void behind becomes the real facility for the installation.



Pannello Eclettico o carte da parati?

Produciamo i pannelli e le carte da parati tecnologicamente evolute nella stessa azienda. Massima performance di abbinamento **TOTAL LOOK** e di progetto soluzione.

Eclectic panel or wallpaper?

We produce the technologically advanced panels and wallpapers in the same company. Maximum performance of **TOTAL LOOK** combination and solution project.



Pareti Green.

Pareti verticali con vero fogliame, senza manutenzione, stabilizzato. Adatto anche per ambienti senza luce.

Green walls.

Vertical walls with real foliage, maintenance free, stabilized. Suitable also for environments without light.



Con Eclettico puoi creare pareti divisorie con costruzione prefabbricata, massima semplicità, velocità di installazione e qualità.

With Eclettico you can create partition walls with prefabricated construction, maximum simplicity, speed of installation and quality.



New Eclettico Kit Sound. È un nuovissimo sistema in Bluetooth che trasforma il pannello **Eclettico** in **vibrazione acustica senza speaker**.

New Eclectic Kit Sound. is a brand new Bluetooth system that transforms the Eclectic panel into acoustic vibration without a speaker.



Tagli di luce a parete o a soffitto creiamo tagli di luce, con grande effetto scenografico. È montato in 7 minuti.

Cuts of light on the wall or ceiling we create cuts of light, with great scenographic effect. It is assembled in 7 minutes.



Classico o moderno? Realizziamo il tuo stile nella nostra produzione customizzata 100% in Italia.

Classic or modern? We create your style in our 100% customized production in Italy.

Tipologie di pannelli



TYPES OF PANELS



ECLETTICO PRINT

Superficie materica stampata con decori a piacere.
Material surface printed with decorations as desired.

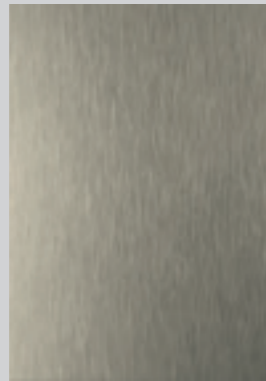

ECLETTICO MATERIAL

Superficie in vari materiali, finiture, essenze, colori, metallici, specchio o lavagna.
Surface in various materials, finishing, essences, colors, materials, mirror or blackboard.

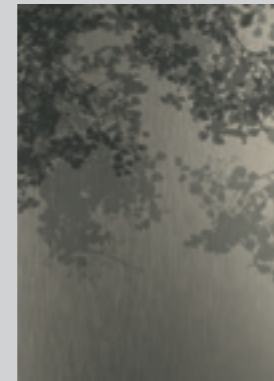

ECLETTICO MATERIAL PRINT

La versione personalizzabile tramite stampa digitale di tutti i MATERIAL Eclettico (ad esclusione degli specchi) che possono essere sovrastampati con decori a piacere.
The customizable version by digital printing of all the Eclettico MATERIALS (except for the mirrors) which can be overprinted with any decorations.

Dimensioni pannelli - Panels sizes

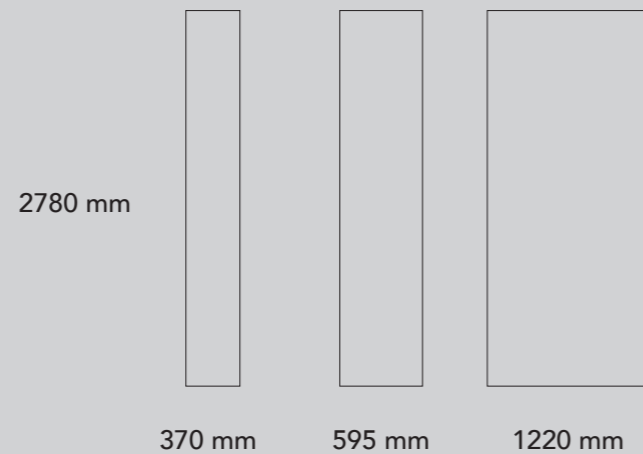

Only for Eclettico Ritmo



ECLETTICO RITMO

Particolare superficie a cannettè dogata proposta in finiture opache e lucide e in svariati colori in 3D.
Particular cannettè slatted surface proposed in matt and glossy finishing and in various colors.

ACCESSORI DI SERIE STANDARD ACCESSORIES



01 Profili in alluminio naturale a "L" per chiusura parte superiore e laterale dei pannelli installati.
L-shaped profiles in natural aluminium for upper and side closing of installed panels.

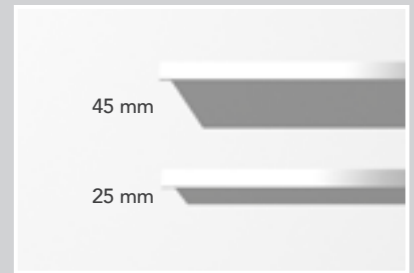
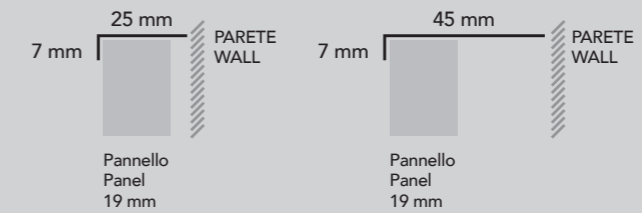

02 Pannello Eclettico Print.
Eclettico Print panel.

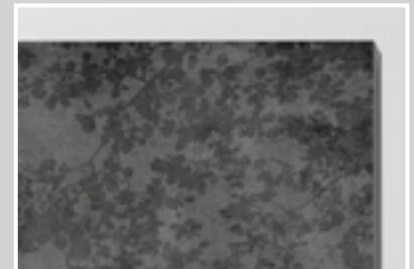
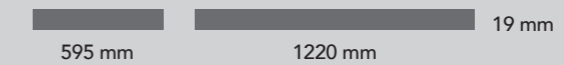

03 Barre in alluminio da fissare su parete e retro pannello.
Aluminium bars to be fixed on wall and on the back of panel.

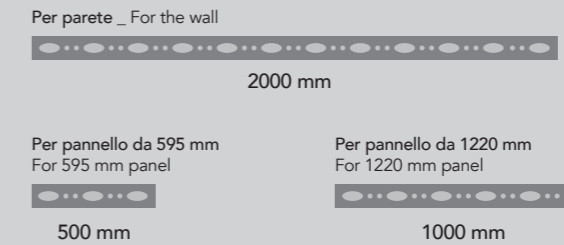

04 Lamelle in legno per fissare i pannelli.
Wooden slats to fix the panels.



CONSIGLI UTILI PER IL MONTAGGIO USEFUL ADVICE FOR ASSEMBLY



01

Fissare a parete le barre in dotazione (utilizzare una livella a bolla).
In tal modo si crea un vuoto sanitario tra i pannelli e la parete (**profondità totale 25 mm**).
Fix the supplied bars to the wall (use a bubble level).
This creates a sanitary void between the panels and the wall (**total depth 25mm**).

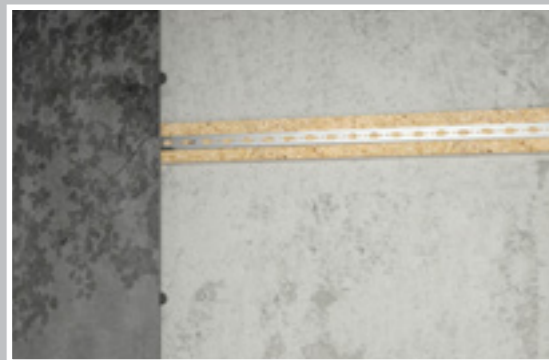

02

Spessori a parete per vuoto sanitario più ampio. Se si desidera aumentare lo spazio consigliamo di applicare degli spessori a parete di spessore 18 mm.
Vedi esempio nell'immagine a fianco (**profondità totale 45 mm**).
Wall spacers for wider sanitary void. Should you want to increase the space we recommend applying 18 mm thick wall spacers.
See example in the image alongside (**total depth 45 mm**).

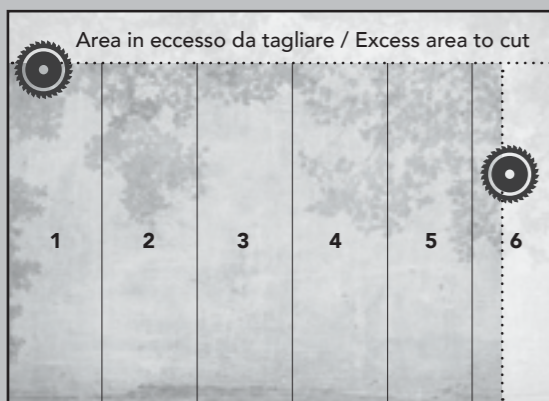

03

Tagliare i pannelli ad altezza della parete togliendo 15 mm per agganciarli alle barre e poter usufruire della regolazione del piedino.
Cut the panels at the height of the wall by removing 15mm to hook them to the bars and take advantage of the foot adjustment.

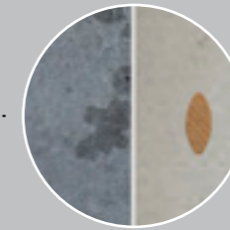
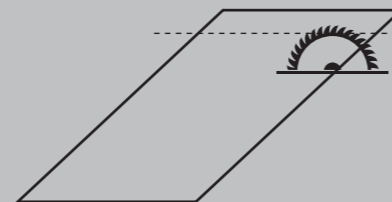

Lamelle in legno per fissare i pannelli.
Wooden slats to fix the panels.



04

Fissare sul retro pannello le barre in dotazione (utilizzare una livella a bolla).
Fix the supplied bars on the rear panel (use a bubble level).

05

Applicare le lamelle di legno sulle fessate dei pannelli per fissarli.
Apply the wooden slats to the side grooves of the panels to fix them.



06

Agganciare sulla barra a muro il primo pannello a sinistra della parete.
Seguire la numerazione stampata sul pannello.
Hook the first panel on the left of the wall onto the wall bar.
Follow the numbering printed on the panel.

07

Tagliare la parte destra in eccesso dell'ultimo pannello.
Considerare che il profilo di chiusura è di spessore 7 mm.
Cut the excess right part of the last panel.
Consider that the closing profile is 7 mm thick.



08

Applicare i profili in alluminio sulla parte superiore e laterale dei pannelli installati.
Sulla parte inferiore suggeriamo di applicare un battiscopa (non in dotazione) o di applicare il profilo capovolto.
Apply the aluminum profiles on the top and side of the installed panels.
On the lower part we suggest to apply a skirting board (not supplied) or to apply the profile upside down.

CONSIGLI PER LA PULIZIA DEL PANNELLO _ CLEANING THE ECCLETTICO PANEL

Pulire il pannello con un panno morbido bagnato con acqua e poco sapone. (Rapporto consigliato: 1 litro d'acqua con un cucchiaino da tavola di sapone liquido).
Evitare di pulire i pannelli con prodotti aggressivi e materiali abrasivi.
Clean the panel with a soft cloth dampened with water and a little soap. (Recommended ratio: 1 liter of water with a tablespoon of liquid soap).
Avoid cleaning the panels with aggressive products and abrasive materials.



ECLETTICO Print

Pannelli spessore 19 mm finitura cemento bianco effetto murale stampato con le grafiche da catalogo Wallpaper Adriani e Rossi o su richiesta.

19 mm thick panels with white concrete finish, mural effect printed with the Wallpaper Adriani and Rossi catalog graphics or upon request.

Dimensioni pannello_ Panel sizes

- L 595 H 2780 mm ECP60X240
- L 1220 H 2780 mm ECP122X320

Specificare il codice della grafica da stampare sul pannello.

Specify the graphic code to be printed on the panel.

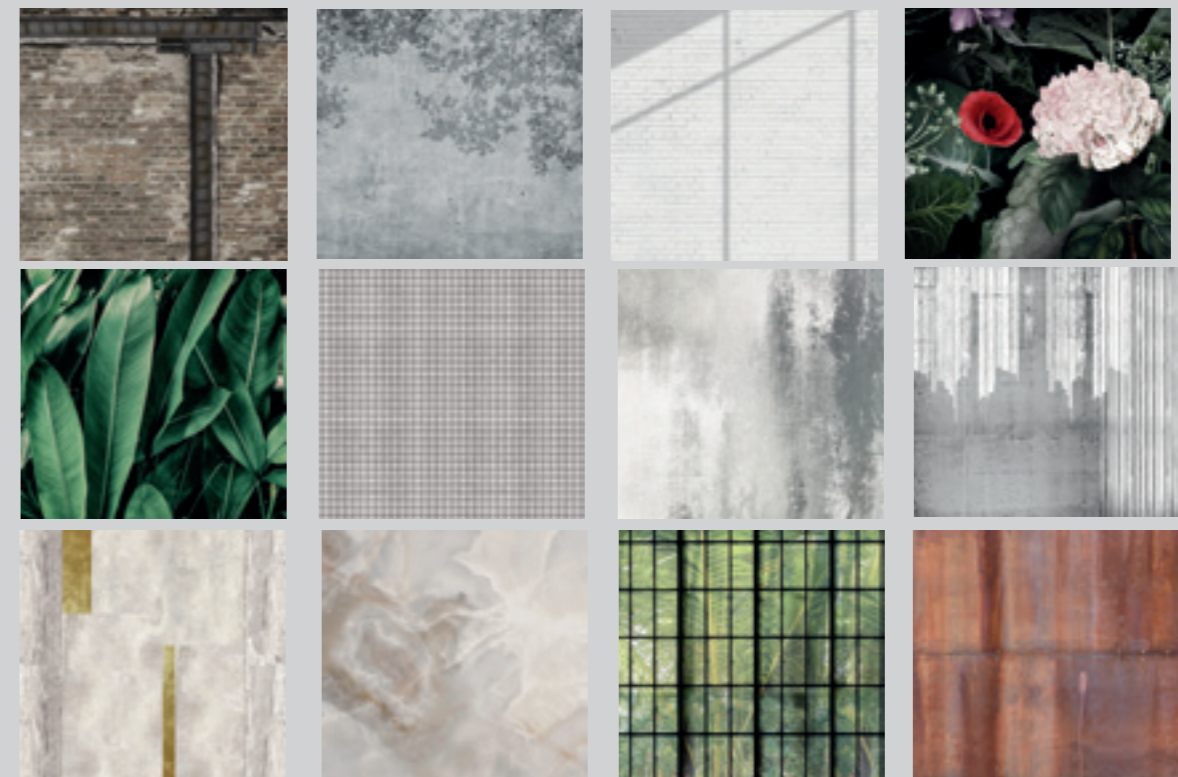

Scarica i soggetti dai cataloghi Adriani e Rossi Wallpaper

Download subjects to wallpaper catalogues



Wallpaper Vol. 4









ECLETTICO Materials

Pannelli spessore 19 mm in un'ampia gamma di particolari finiture.
19 mm thick panels a wide range of particular finishes.

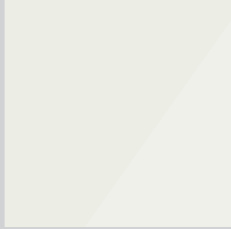
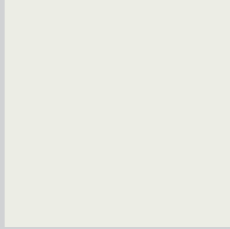
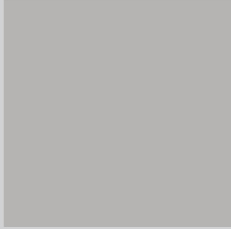
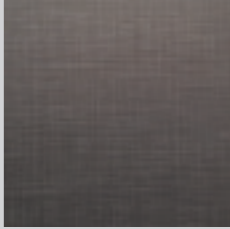
Dimensioni pannello_ Panel sizes

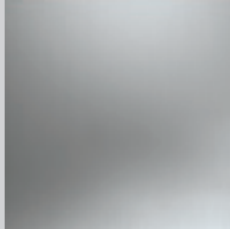
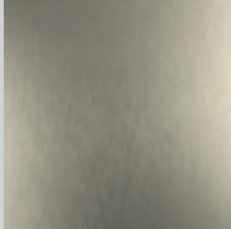
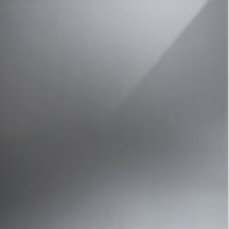
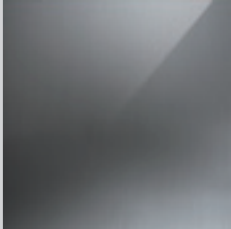
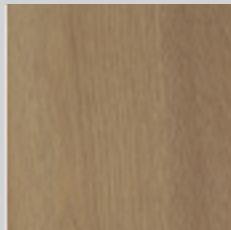
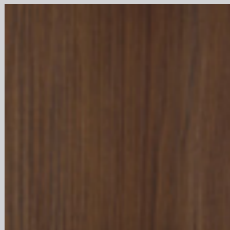
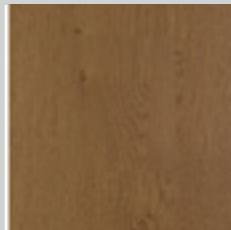
- L 595 H 2780 mm **ECM60X240**
- L 1220 H 2780 mm **ECM122X320**

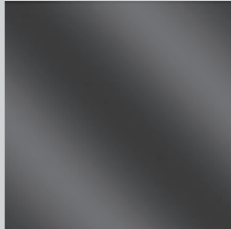
Specificare il codice del materiale scelto.
Specify the graphic code to be printed on the panel.

				
300 Bianco Lucido Glossy White	718 Bianco Fiocco Fiocco White	570 Mocaccino Opaco Matt Mocaccino	190 Strip Nero Black Strip	
				
410 Steel High Gloss	590 Steel Opaco Matt Steel	210 Avorio Metallico Metallic Ivory	606 Lamisteel Grigio Lamisteel Grey	608 Lamisteel PAL Lamisteel Pal
				
721 Rovere chiaro Light oak	722 Noce Catania Catania walnut	726 Rovere rosso Red oak		
				
704 Lavagna Blackboard		607 Specchio Fumé Smoked Mirror	260 Specchio Argento Silver Mirror	

NO PRINT



ECLETTICO Materials Print

Pannelli spessore 19 mm, una gamma di finiture stampabili con grafiche selezionate o su richiesta.
 Panels thickness 19mm, a range of printable finishes with selected graphics or upon request.

Dimensioni pannello_ Panel sizes

- L 595 H 2780 mm **ECMP60X320**
- L 1220 H 2780 mm **ECMP122X440**

Specificare il codice del materiale e la grafica da stampare sul pannello.
 Specify the code of the material and the graphics to be printed on the panel.

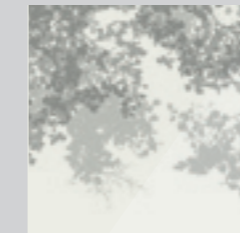

300 Bianco Lucido
Glossy White

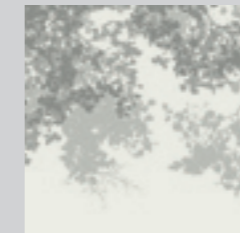

718 Bianco Fiocco
Fiocco White

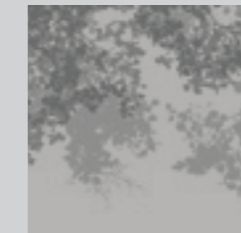

570 Mocaccino Opaco
Matt Mocaccino

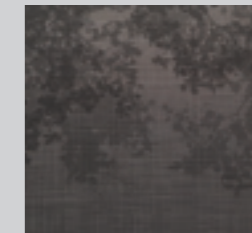

190 Strip Nero
Black Strip

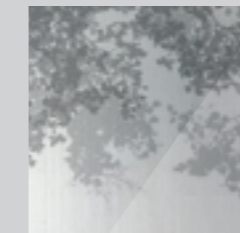

410 Steel High Gloss



590 Steel Opaco
Matt Steel

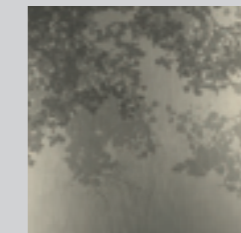

210 Avorio Metallico
Metallic Ivory

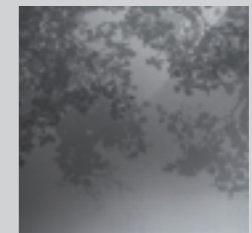

606 Lamisteel Grigio
Lamisteel Grey

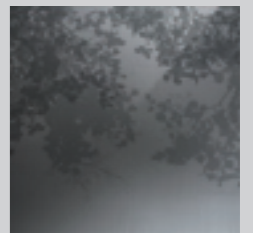

608 Lamisteel PAL
Lamisteel Pal

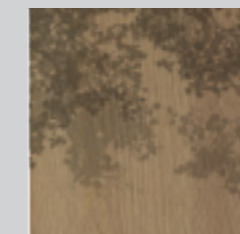

721 Rovere chiaro
Light oak

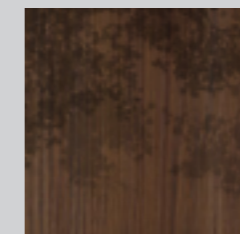

722 Noce Catania
Catania walnut

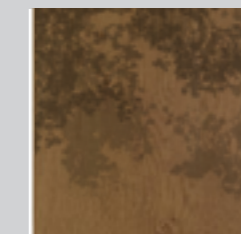

726 Rovere rosso
Red oak

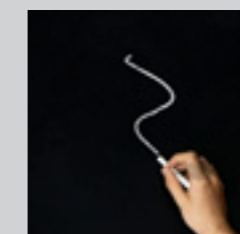

704 Lavagna
Blackboard



Scarica i soggetti dai cataloghi Adriani e Rossi Wallpaper
 Download subjects to wallpaper catalogues



Wallpaper Vol. 4



ECLETTICO Ritmo

DECORATIVI 3D.
3D DECORATIVE.

Pannelli dogati spessore 19 mm in un'ampia gamma di particolari finiture.
19 mm thick slatted panels with wide range of finishes.

Dimensioni pannello_ Panel sizes

- L 370 H 2780 mm **ECR37X165**
- L 595 H 2780 mm **ECR60X280**
- L 1220 H 2780 mm **ECR122X430**

Specificare il codice del materiale scelto.
Specify the graphic code to be printed on the panel.



300 Bianco Lucido
Glossy White



718 Bianco Fiocco
Fiocco White

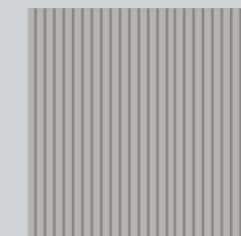

570 Mocaccino Opaco
Matt Mocaccino

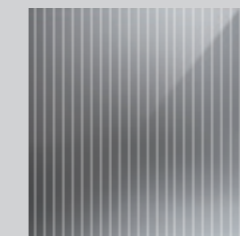

606 Lamisteel Grigio
Lamisteel Grey

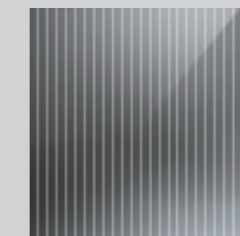

608 Lamisteel PAL
Lamisteel Pal

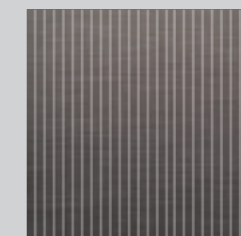

190 Strip Nero
Black Strip

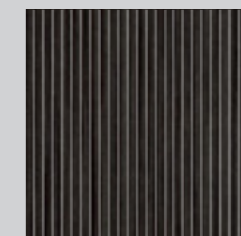

168 Carbon black

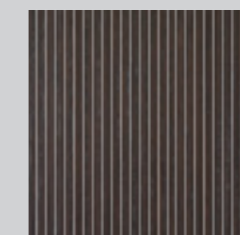

711 Termocotto
Thermocooked

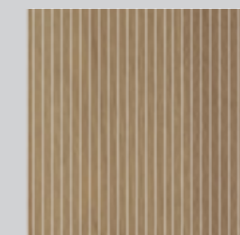

721 Rovere chiaro
Light oak

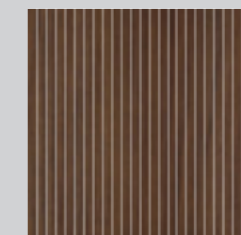

722 Noce Catania
Catania walnut

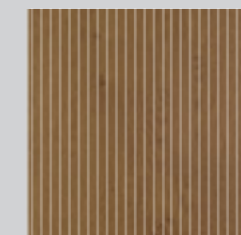

726 Rovere rosso
Red oak

Finitura lavagna

BLACKBOARD FINISH

Possibilità di avere pareti decorative e funzionali allo stesso tempo come le lavagne scrivibili in nero o in bianco lucido con grandi superfici.

Possibility of having decorative and functional walls at the same time as writable black or glossy white boards with large surfaces.

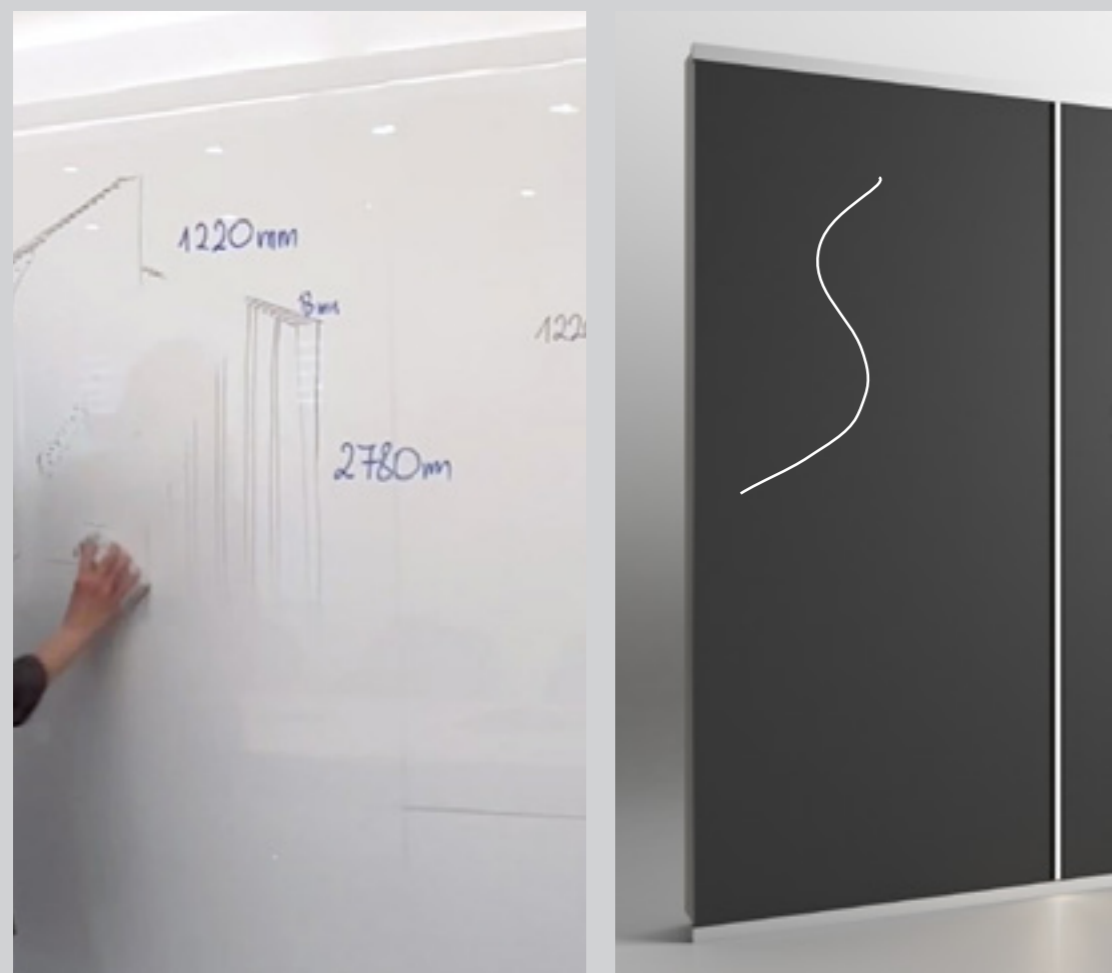

Giardino verticale

VERTICAL GARDEN

Download catalogo
GREEN WALLART

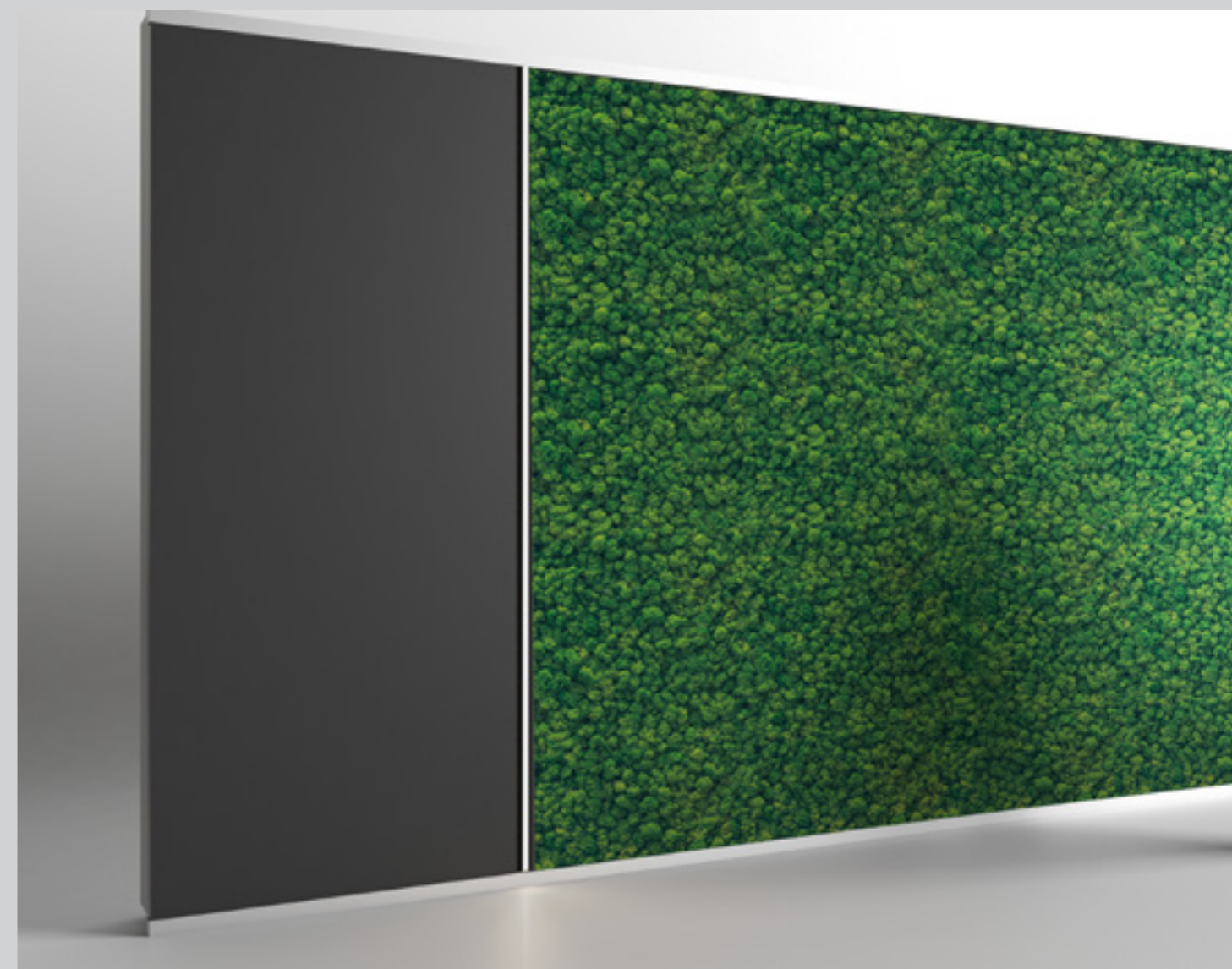

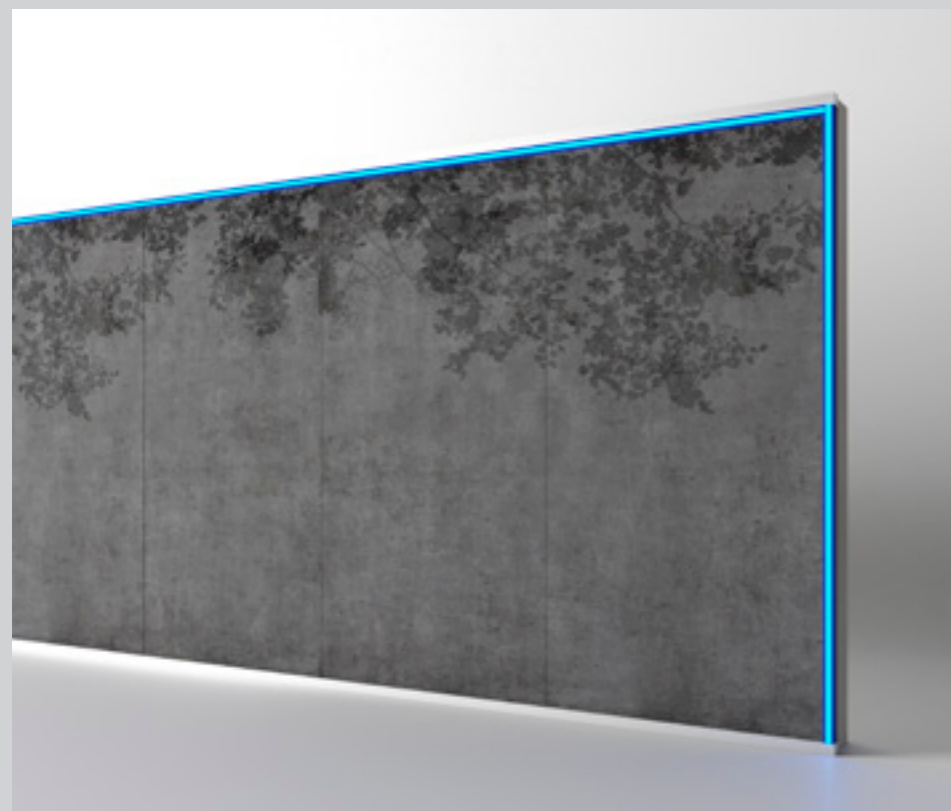

Tagli di luce

LIGHT CUTS

Possibilità di creare tagli di luce.
Possibility of creating light cuts.

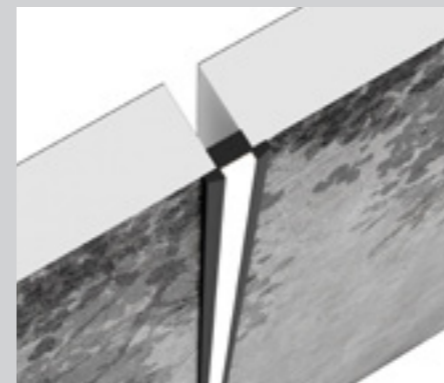

OPTIONAL

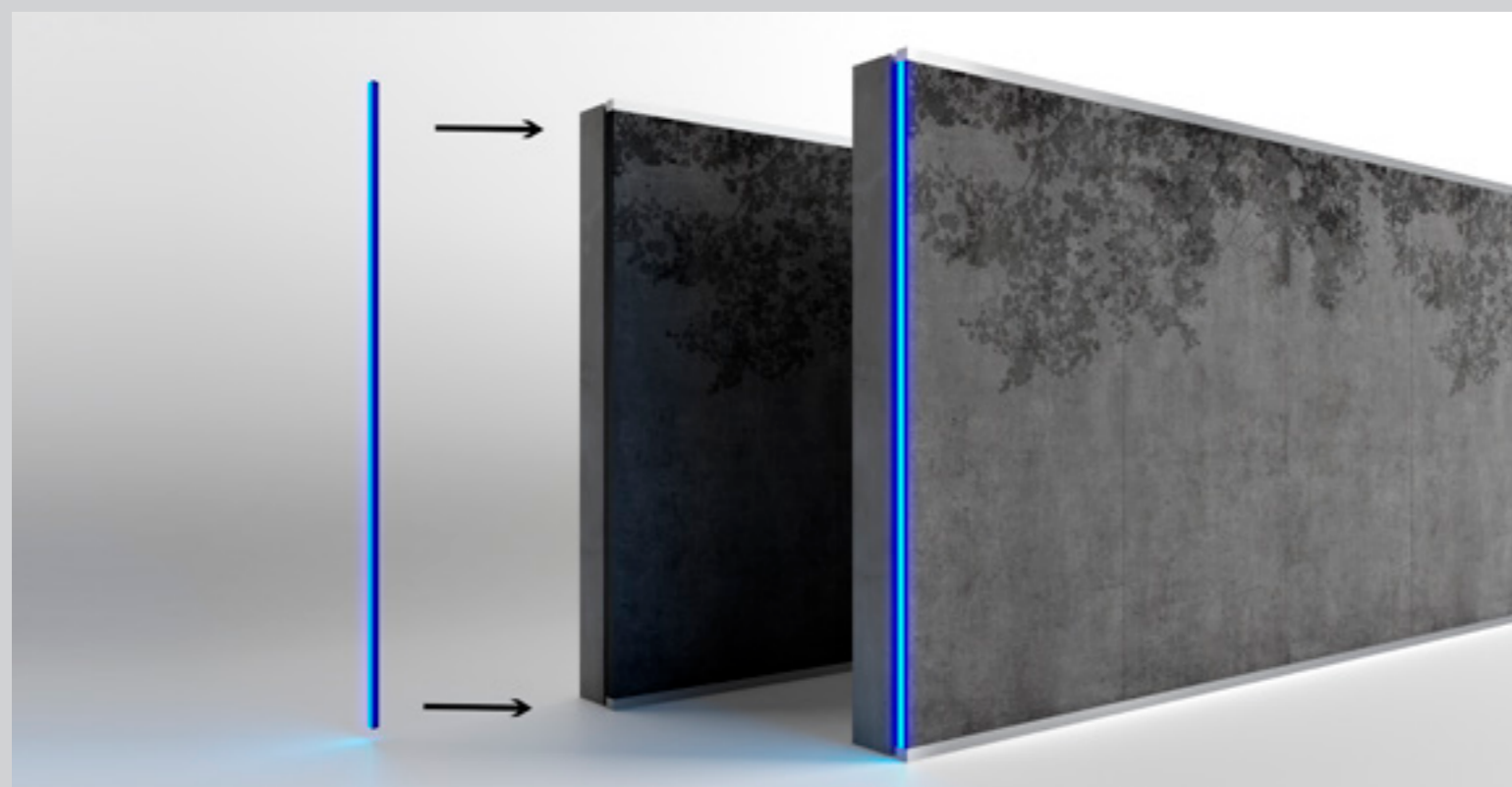

LUCE _ LIGHT LED (OPTIONAL)

Linea luminosa realizzata con profilo in alluminio verniciato nero, diffusore in policarbonato opalino e strip LED ad alta efficienza luminosa ed elevato indice di resa cromatica. Cablato IP30, 12W/m 3000 K, 2 metri di cavo.

Light line made with black painted aluminium profile, opal polycarbonate diffuser and LED strip with high luminous efficiency and high color rendering index. Wired IP30, 12W / m 3000 K, 2 meters of cable.

Codice _ Code
ECLED50MMX5

Esempio per LED L 2750 mm _ Example for LED L 2750 mm
Qtà_Q.ty 55 cod. **ECLED50MMX5**

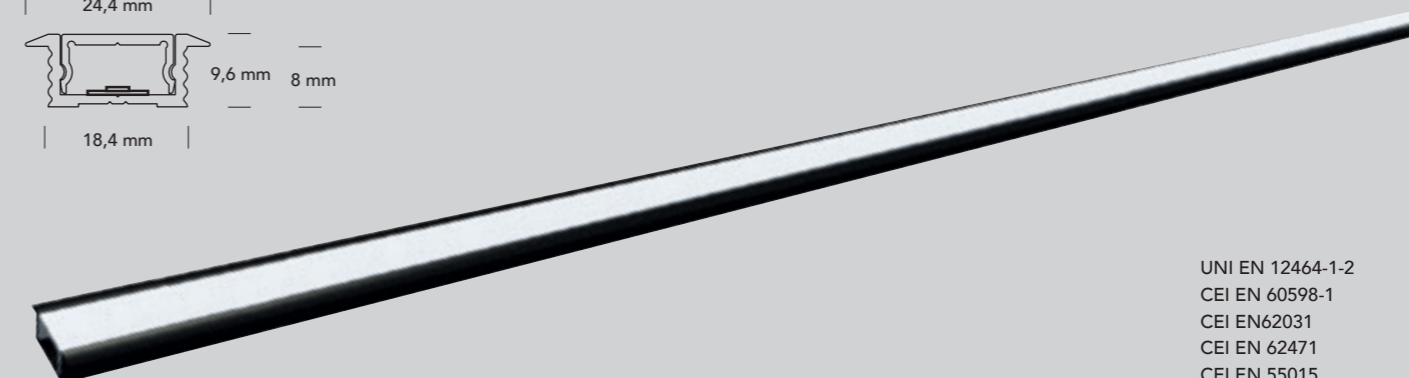
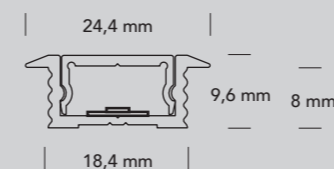

- UNI EN 12464-1-2
- CEI EN 60598-1
- CEI EN 62031
- CEI EN 62471
- CEI EN 55015
- CEI EN 61547
- CEI EN 61000 -3-2
- CEI EN 61000-3-3
- CEI EN 50581-2012



Sound System



Download istruzioni di montaggio
Download assembly instructions



OPTIONAL

ECLETTICO KIT SOUND (OPTIONAL)

Sound System è un nuovissimo sistema in **Bluetooth** che trasforma il pannello Eclettico in vibrazione acustica senza speaker.

Possibilità di inserire un sound kit che trasforma l'intera superficie del pannello Eclettico in una fonte sonora che riproduce il suono sfruttando la materia stessa, offrendo un audio coinvolgente attraverso un'onda sonora costante ed omogenea con audio chiaro e confortevole che si distribuisce uniformemente nello spazio. Eclettico si trasforma in un vero e proprio potente diffusore collegabile attraverso **Bluetooth**.

Sound System is a brand new **Bluetooth** system that transforms the Eclectic panel into acoustic vibration without a speaker.

Possibility of inserting a sound kit that transforms the entire surface of the **Eclettico** panel into a sound source which reproduces sound by exploiting the material itself, offering engaging audio through a constant and homogeneous sound wave with clear and comfortable audio which is distributed evenly in the space. Eclettico is transformed into a real powerful speaker that can be connected via **Bluetooth**.

Codice _ Code
ECSOUNDX695

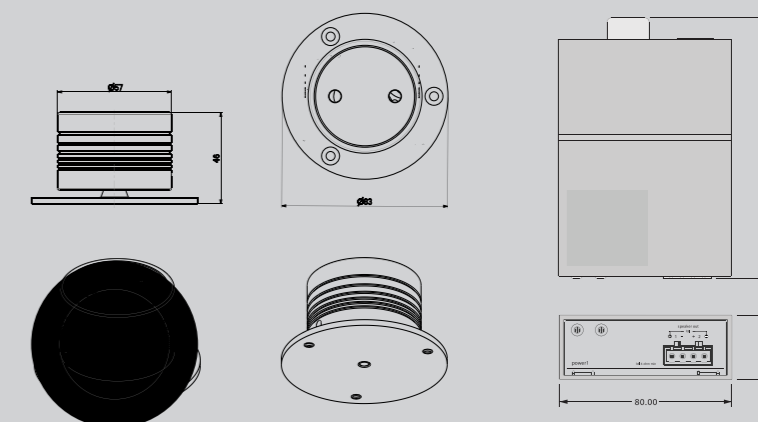

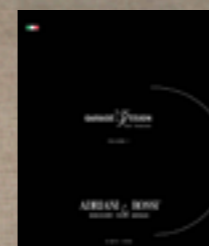

Garage Design
Vol. 1



GARAGE DESIGN
YOUR PASSIONS



Garage Design
Vol. 1





www.geniowallart.com
www.adrianierossi.com
shop.adrianierossi.com

ADRIANI & ROSSI®
DISCOVER YOUR GENIUS

 **Adriani e Rossi Edizioni S.r.l.**
 Sede Operativa ed Uffici / Headquarter
 Via Marco Corner, 1
36016 Thiene (VI) Italy
 Tel: +39 0445 371131
 Web: www.adrianierossi.com
Shop: shop.adrianierossi.com

 Per ordini inviare a / Orders sent to:
Ufficio spedizioni e Magazzino / Warehouse
 Via Brigata Mazzini, 44
36016 THIENE (VI) Italy
 Tel.: +39 0445 367776
 E-mail: (Italia) oggetti@adrianierossi.com
E-mail: (world) export@adrianierossi.com

 **ADI XXII (2011) Compasso d'Oro**
Menzione d'onore - Honorable Mention